

A TOT Z

INKLEUR

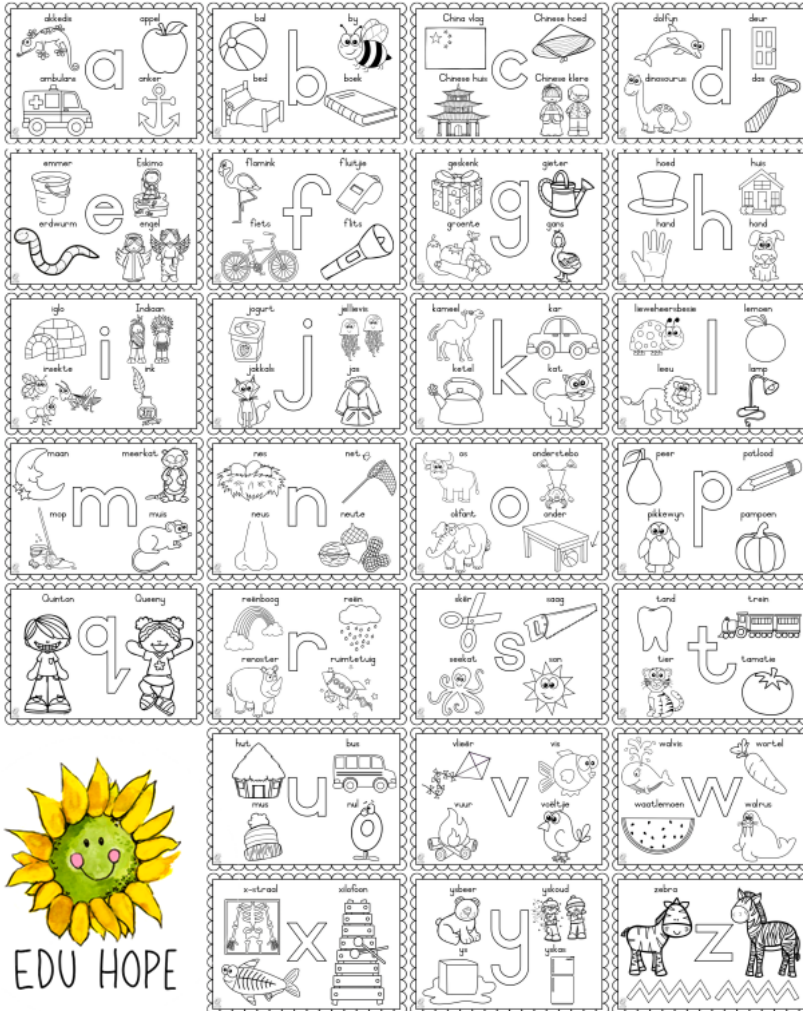

Baie dankie dat julle ons "freebie" afgelaai het. Hoop die kinders gaan dit baie geniet.

Vriendelike Groete
Phyllisity
www.eduhope.co.za

Clipart — Teachers Pay Teachers
<https://www.teacherspayteachers.com/>



akkedis

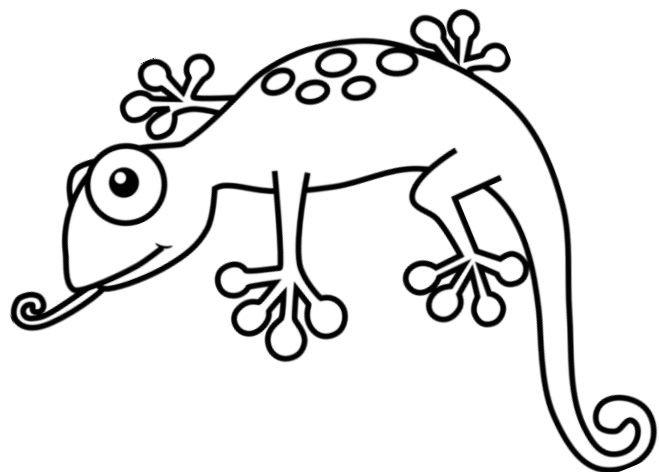

appel

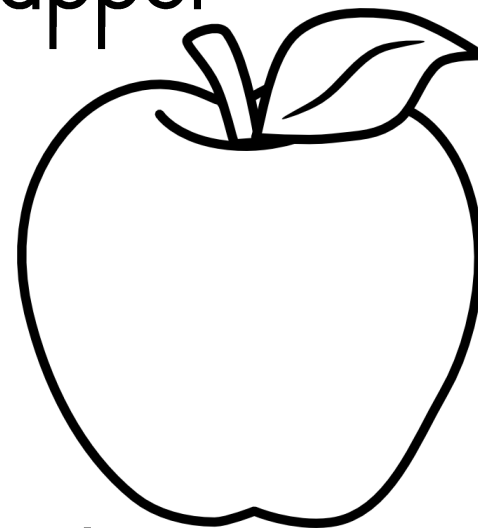

ambulans

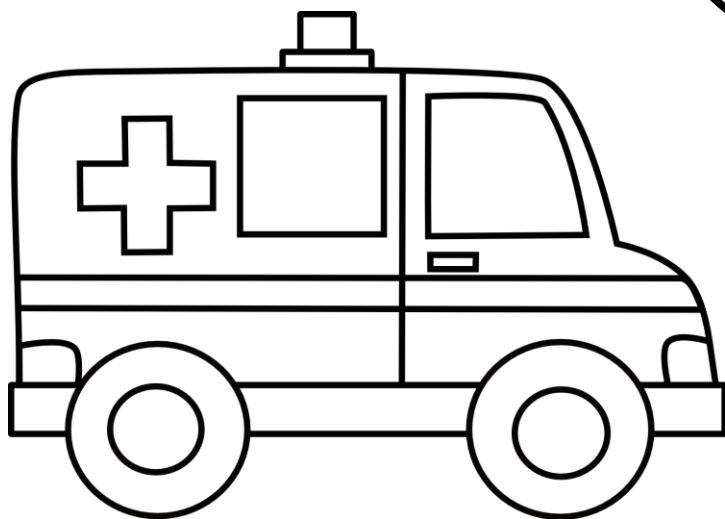

d

anker

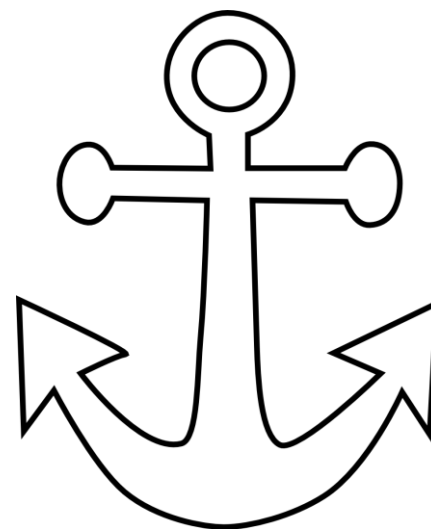

bal

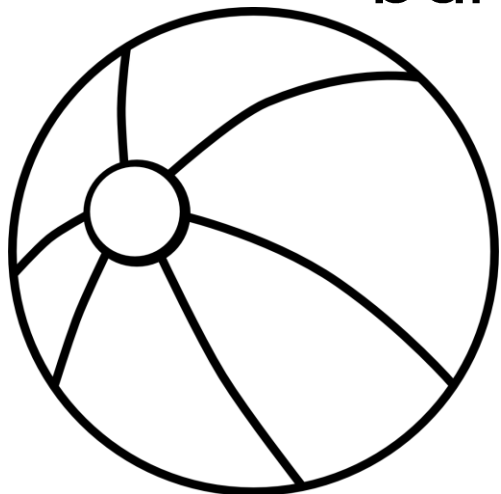

by

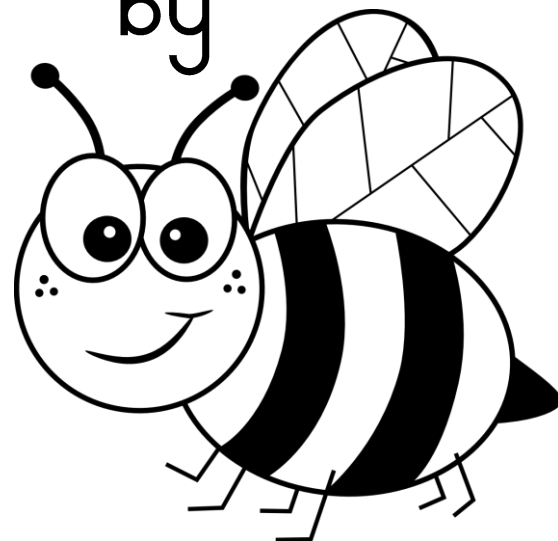

bed

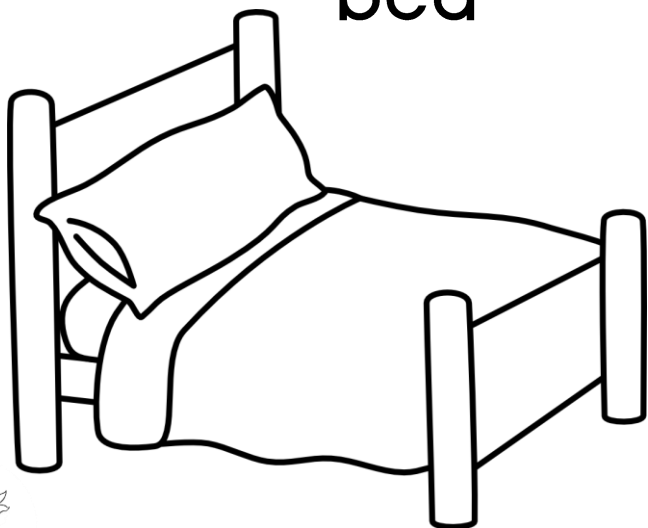

b

boek

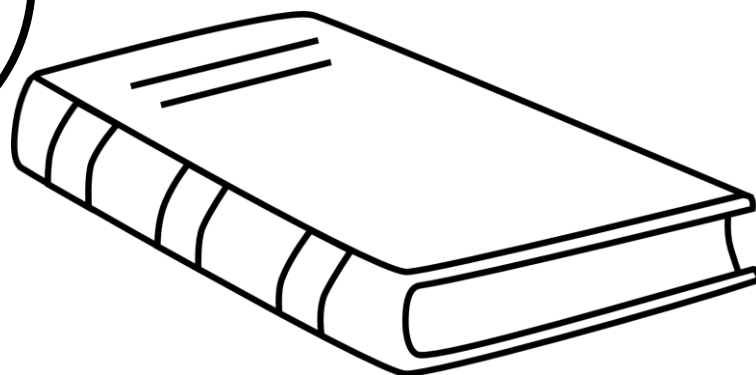

China vlag

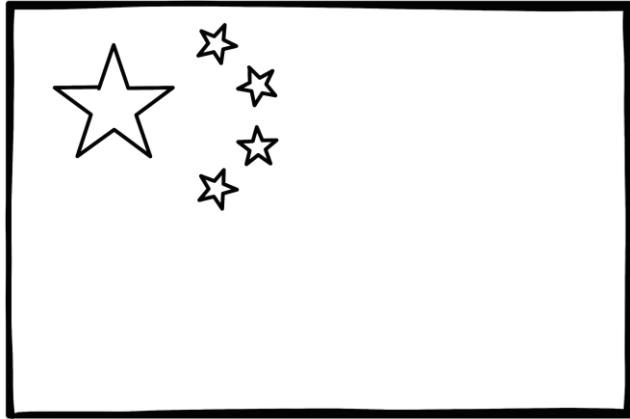

Chinese hoed

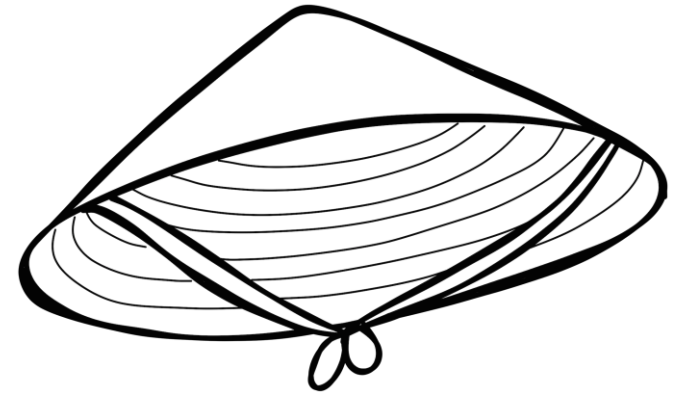

Chinese huis

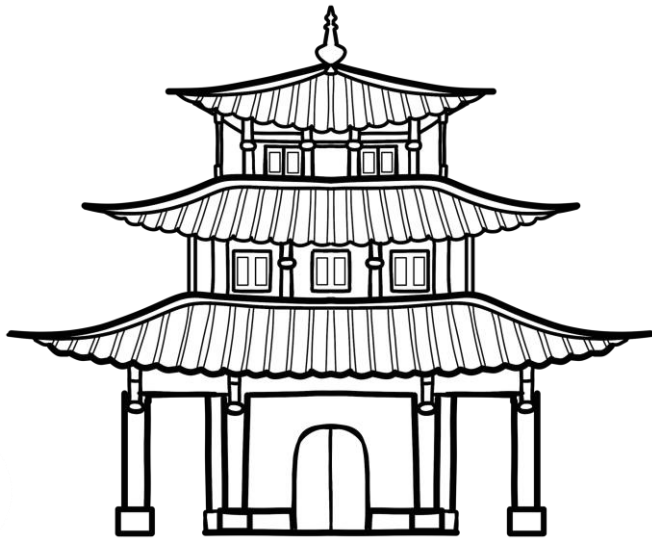

Chinese klere



C

dolfyn



deur

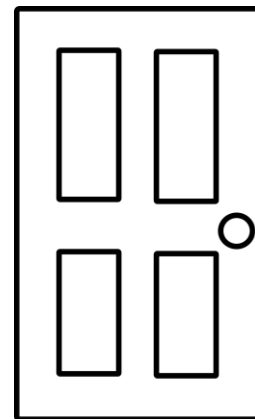

dinosourus

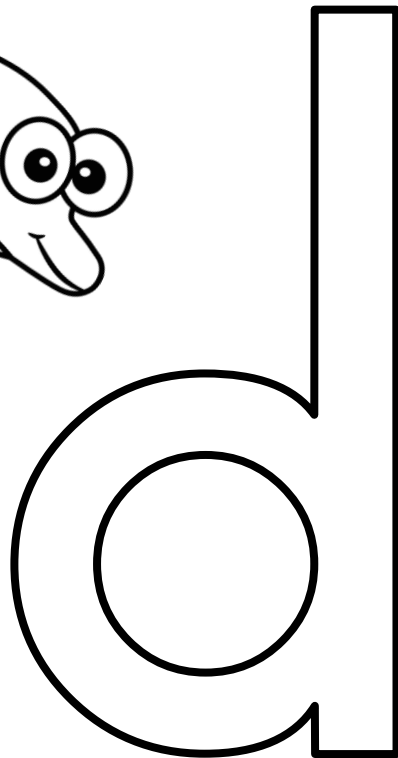
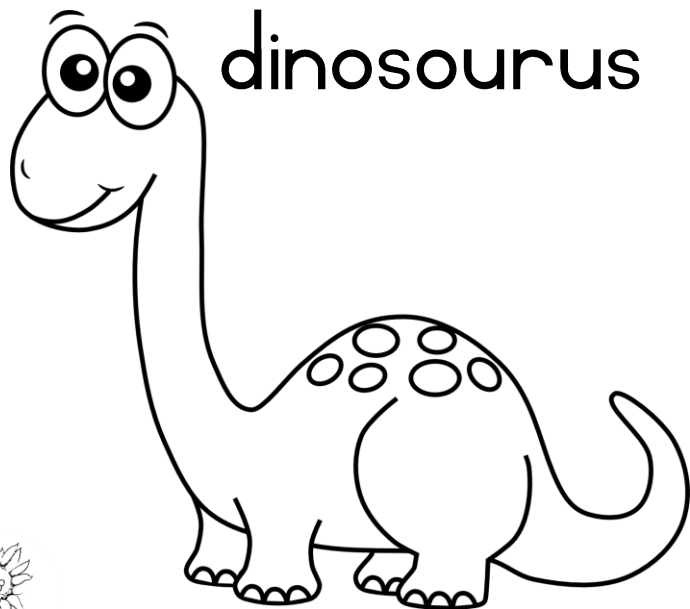

das

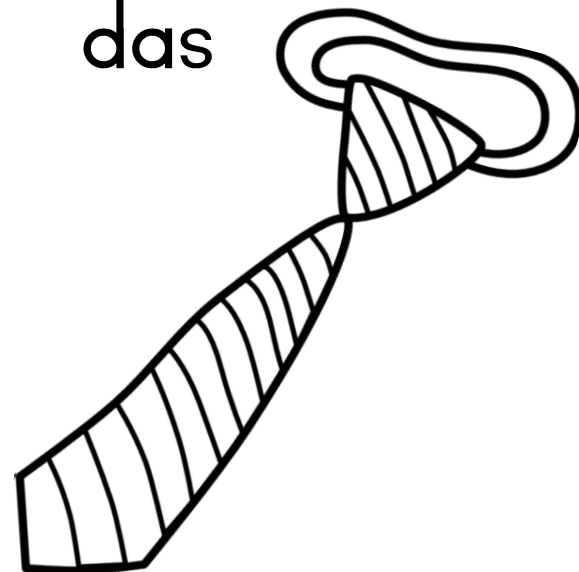

emmer

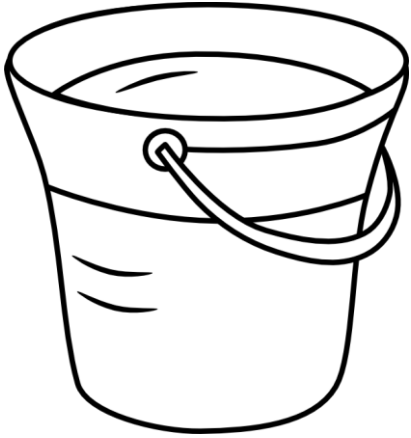

Eskimo

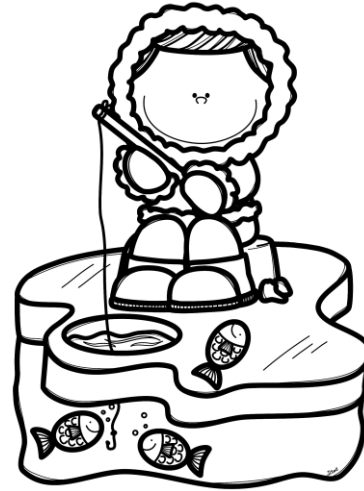

erdwurm

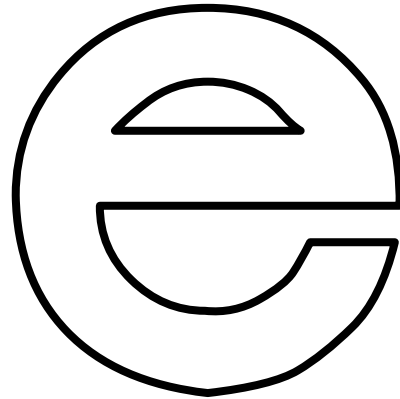
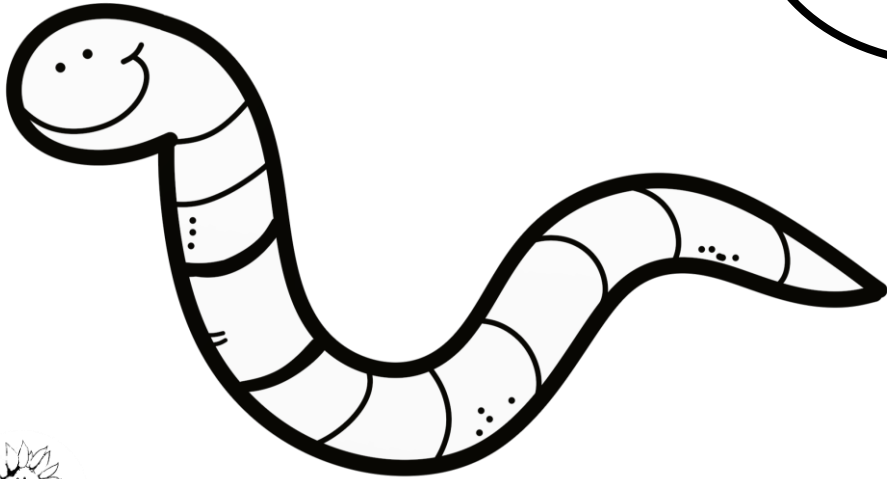

engel



flamink

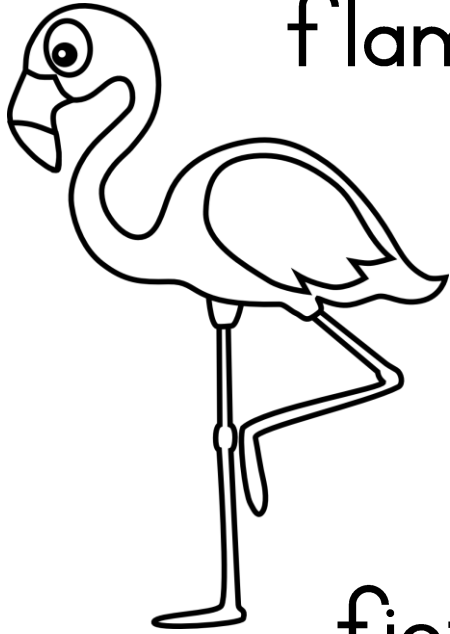

fluitjie

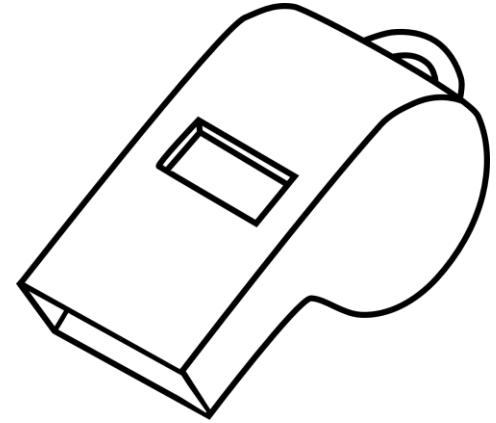

fiets

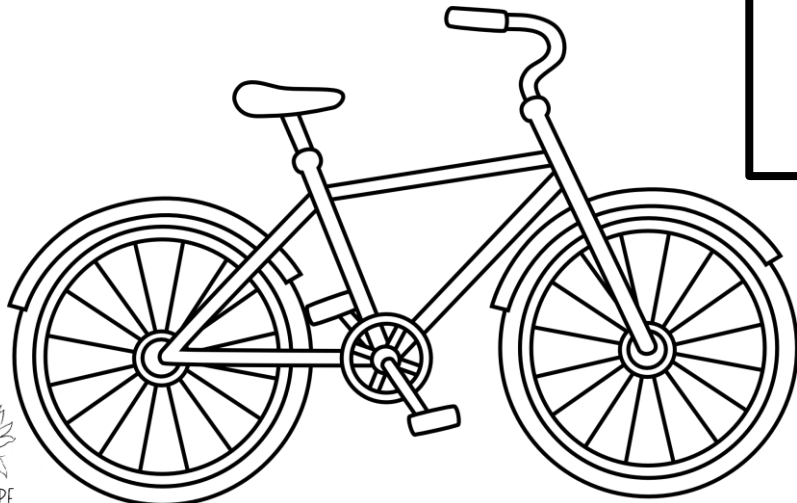

flits

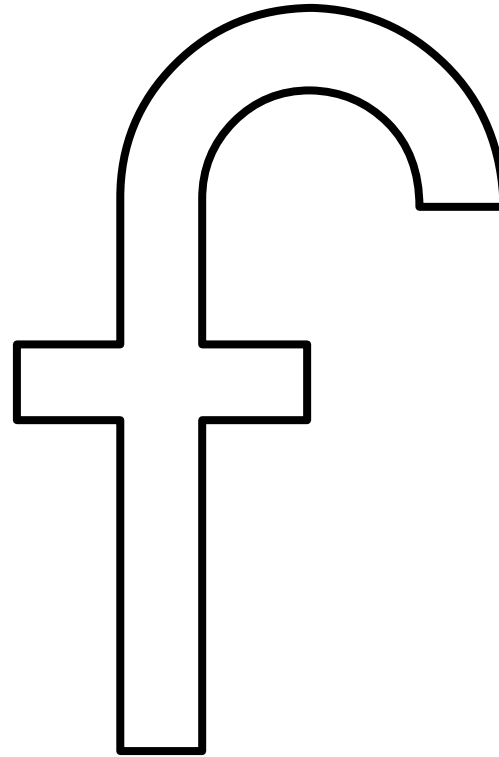
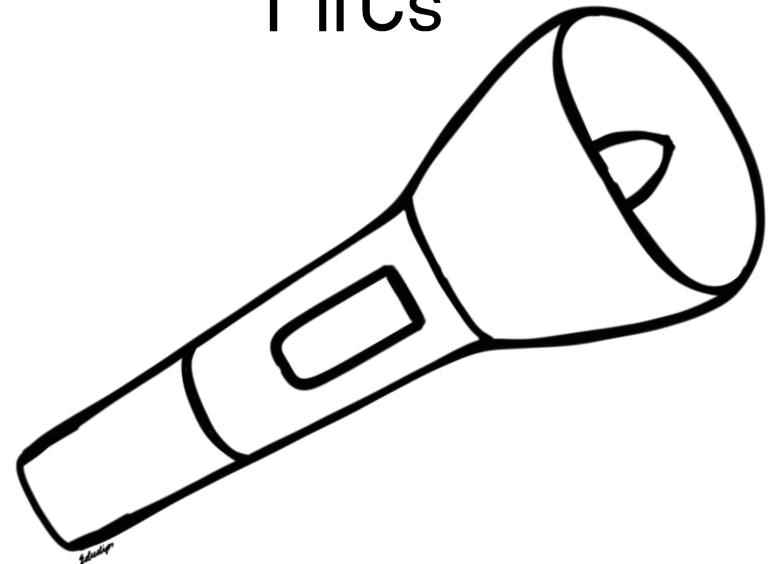

geskenk



gieter

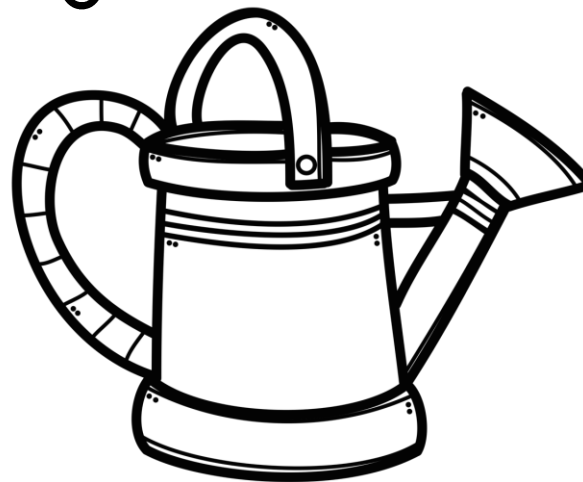

groente

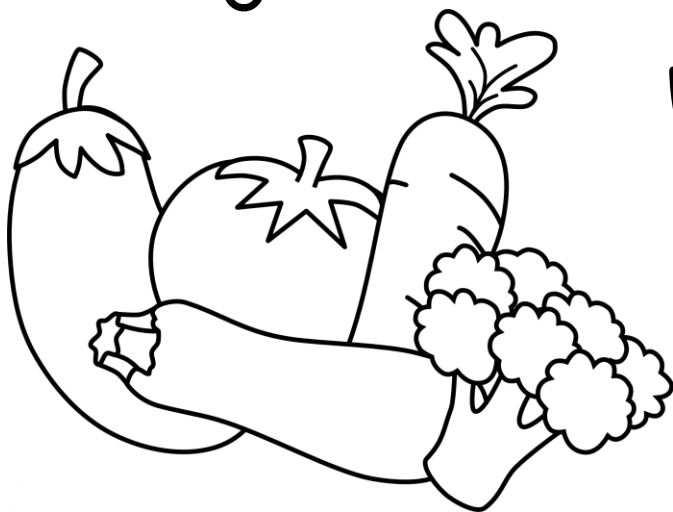

gans

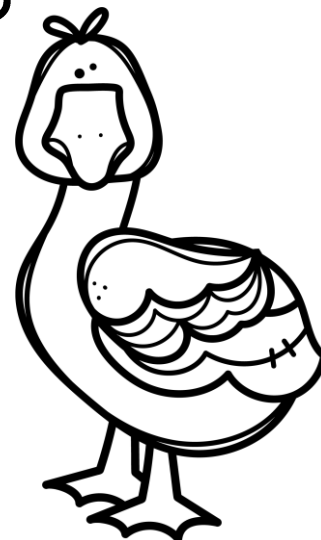

hoed

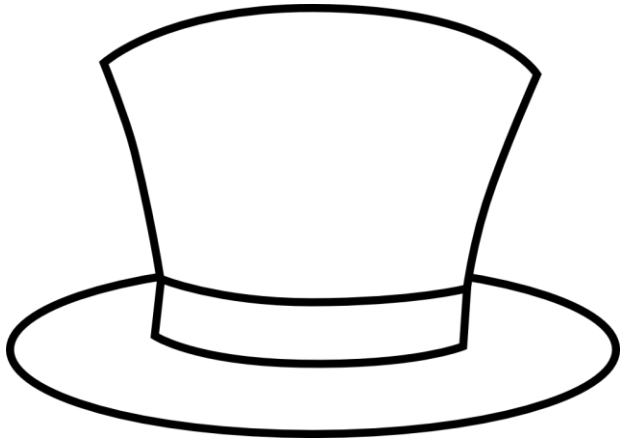

huis



hand

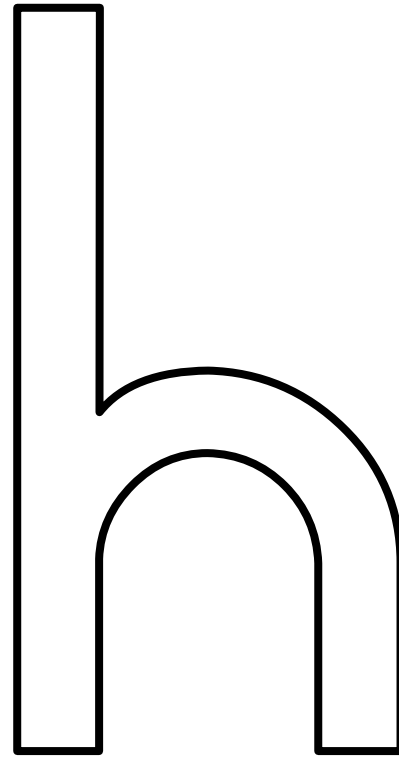
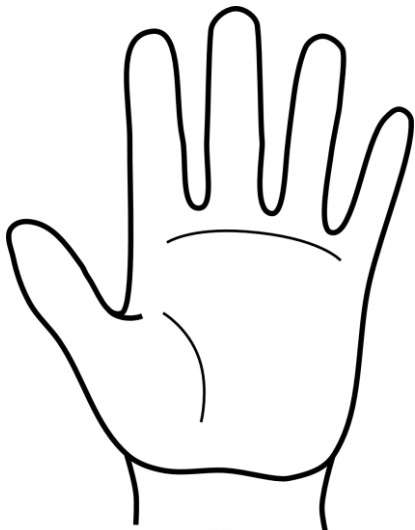

hond

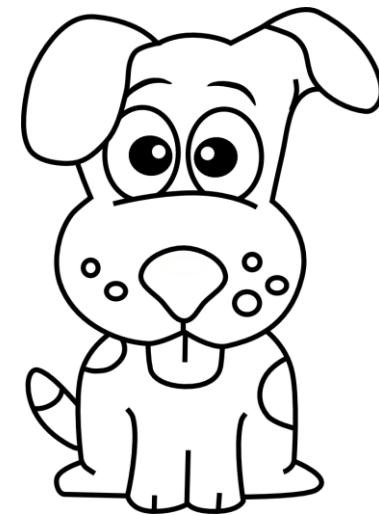

iglo

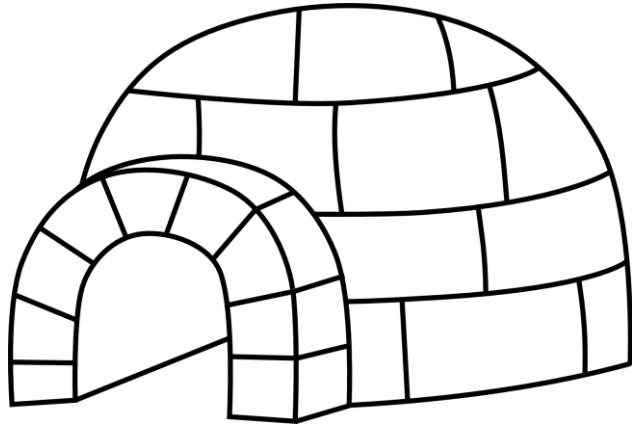

insekte

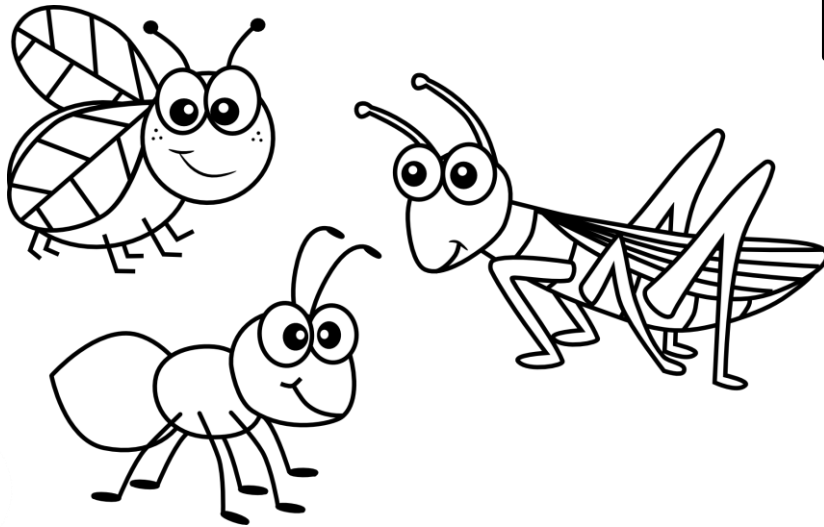

Indiaan

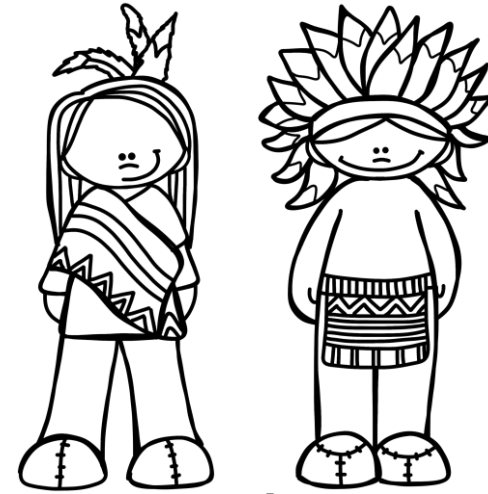

ink



jogurt

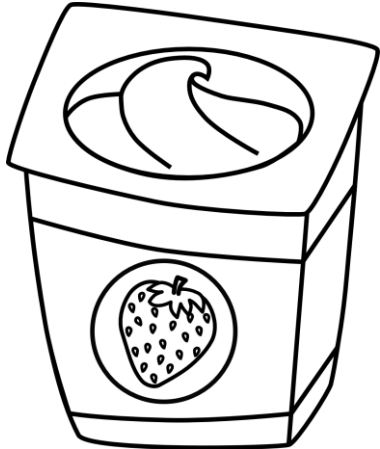

jellievis

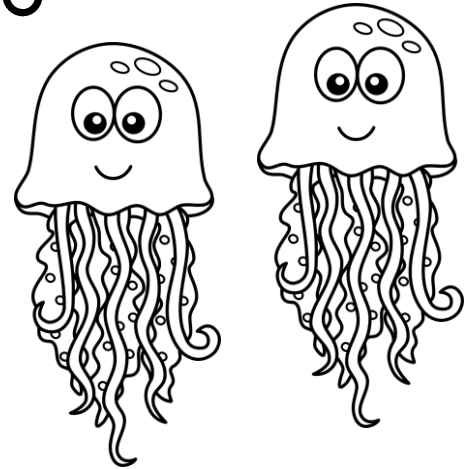

jakkals

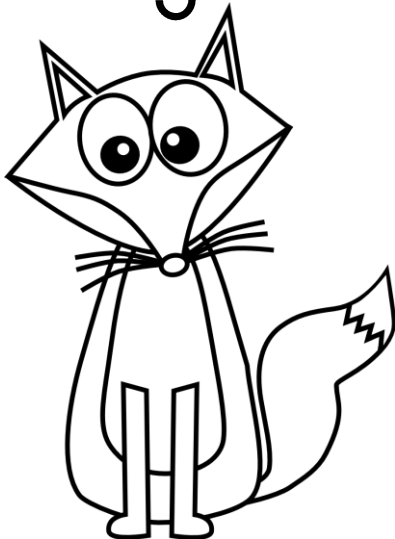

o

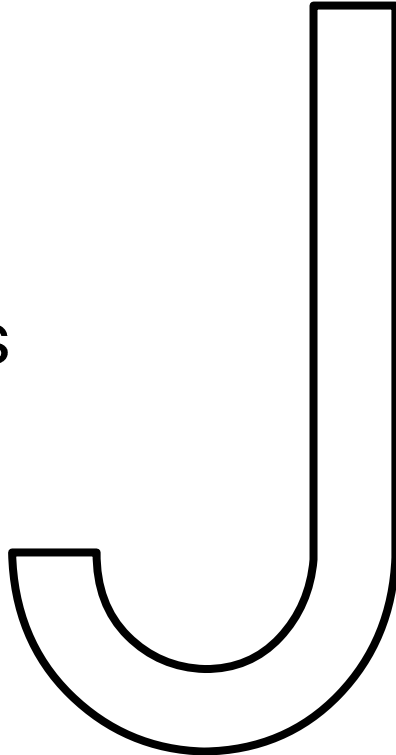

jas



kameel

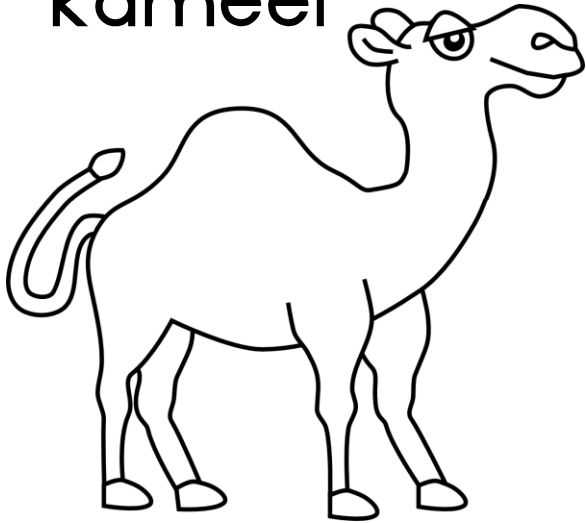

kar

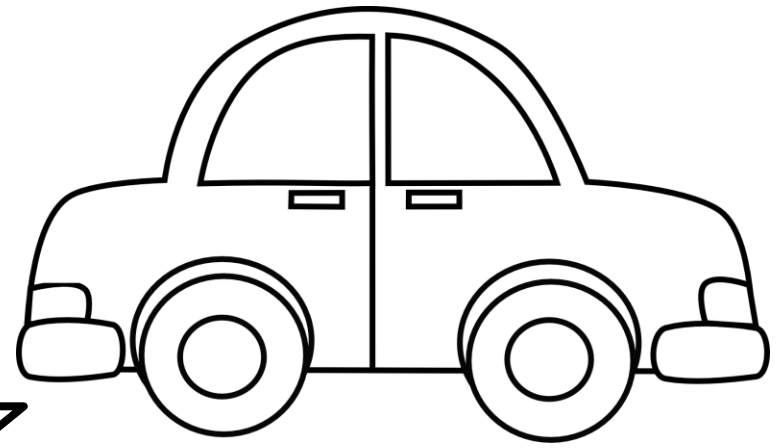

ketel

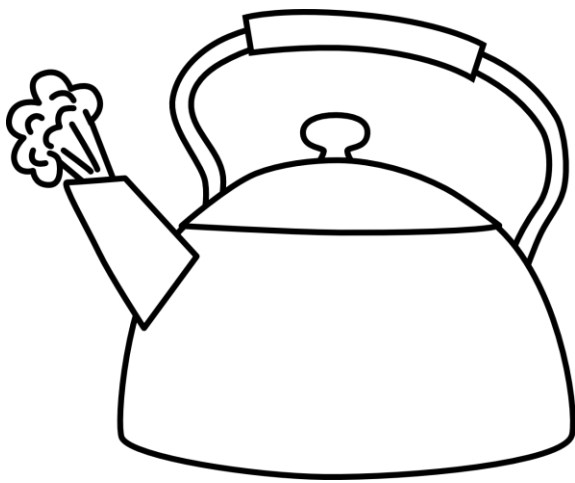

K

kat

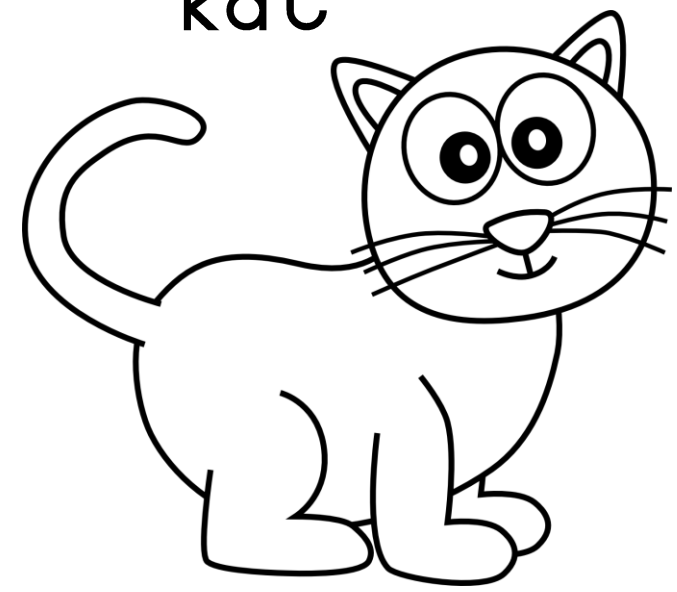

lieweheersbesie

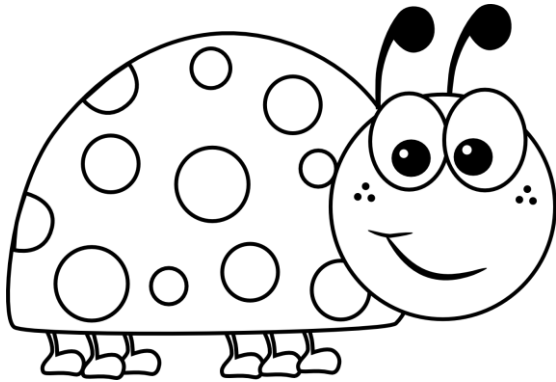

lemoen

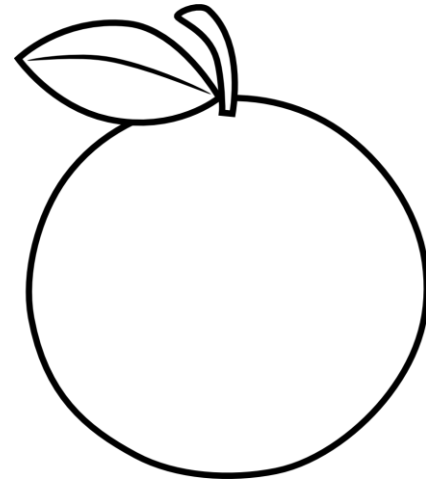

leeu

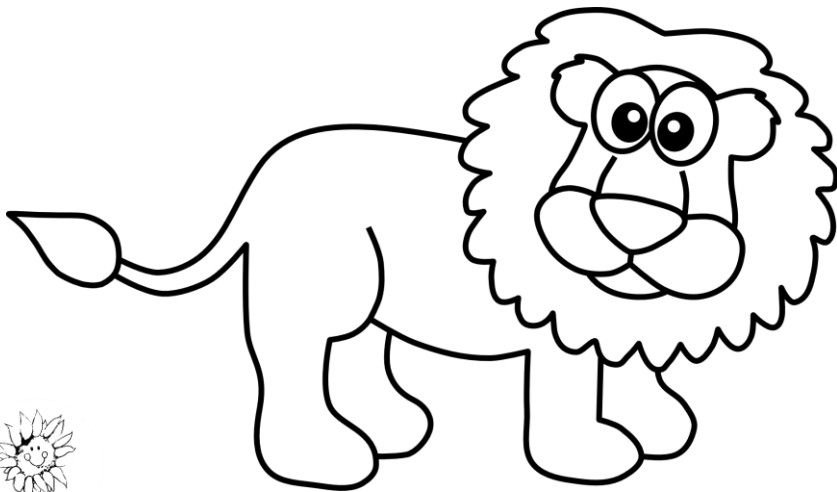

lamp





maan

meerkat



m

mop



muis

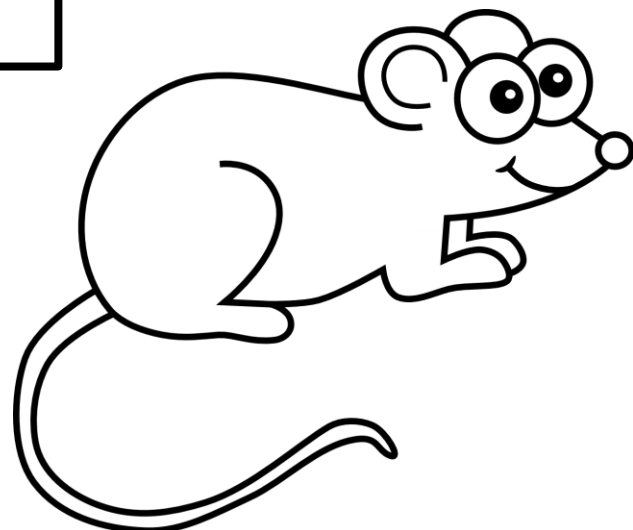

nes

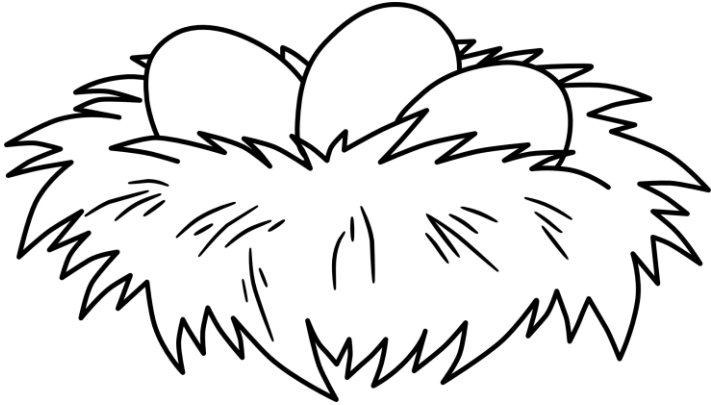

net 

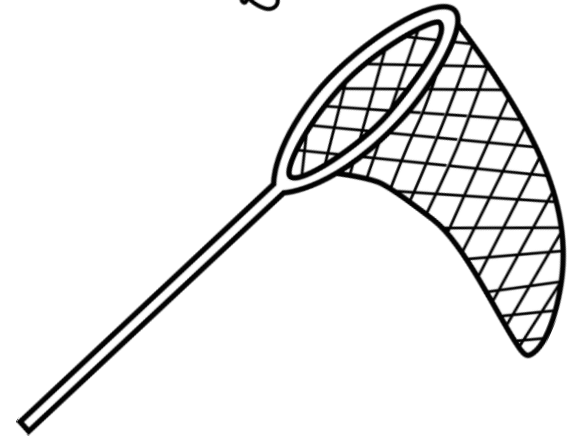

neus

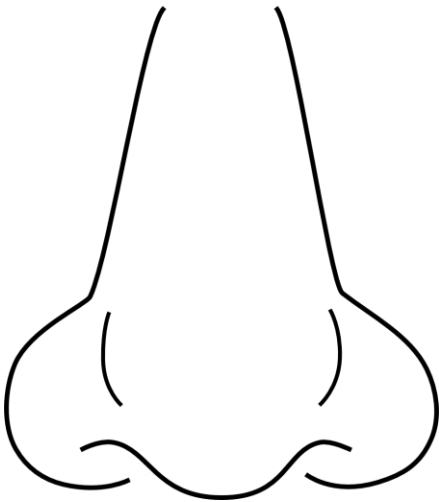

n

neute

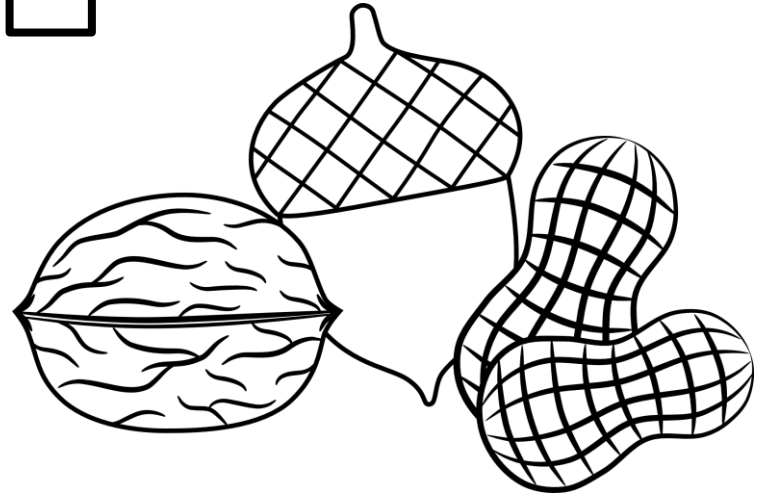

os

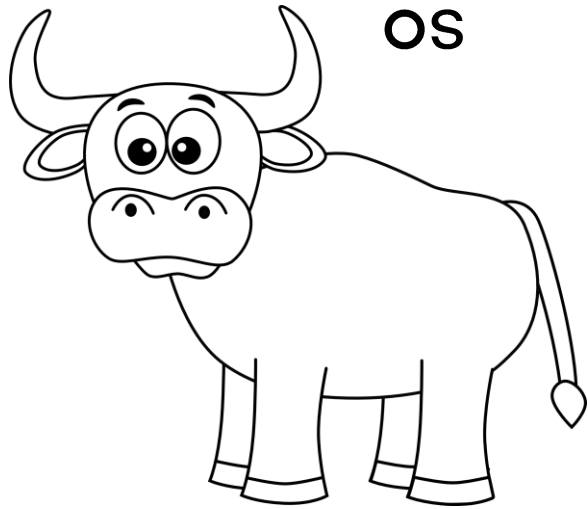

onderstebo

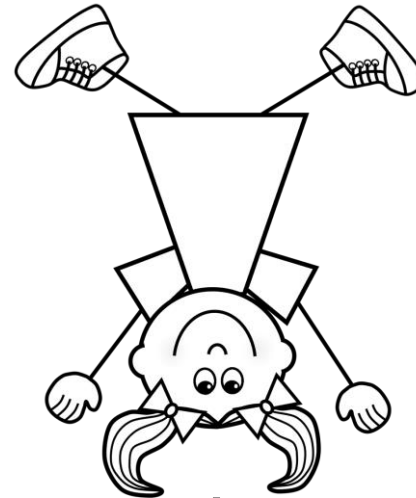

olifant

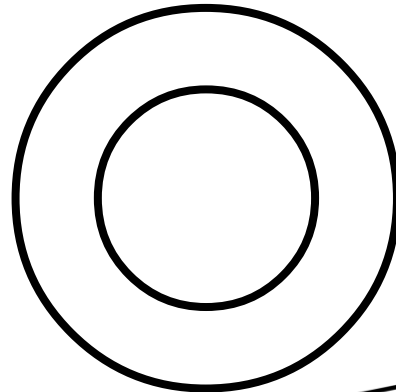
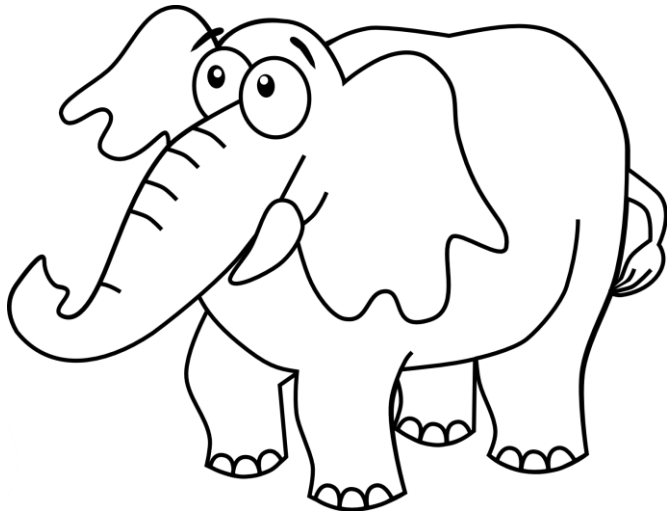

onder

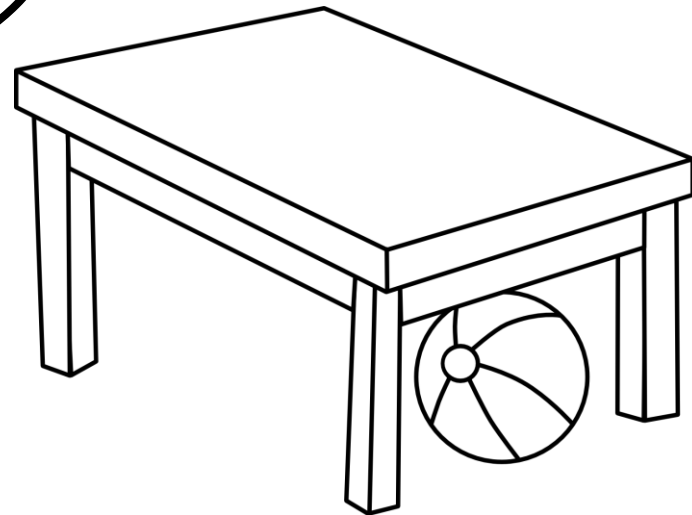

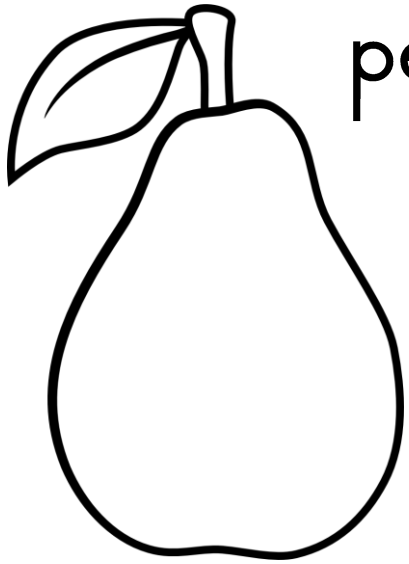

peer

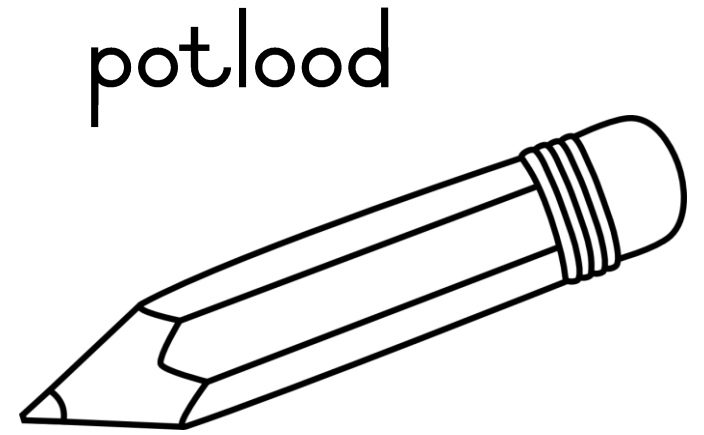

potlood

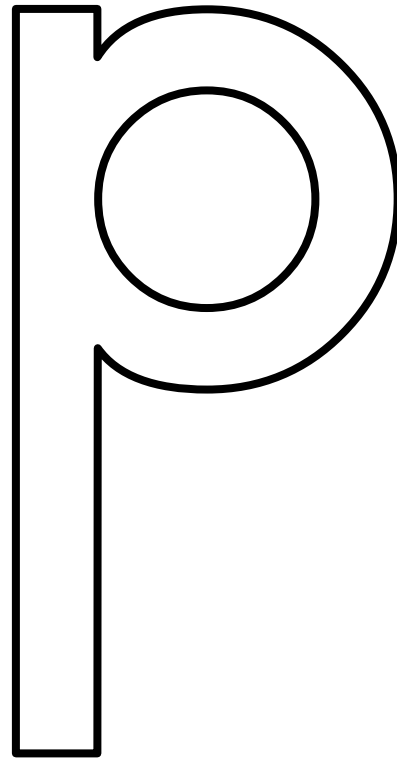

pikkewyn

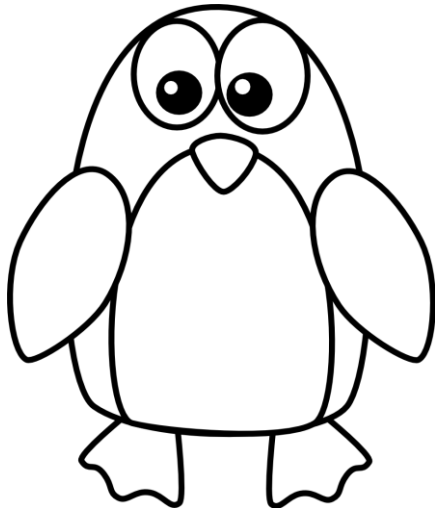

pampoens



Quinton

Queeny

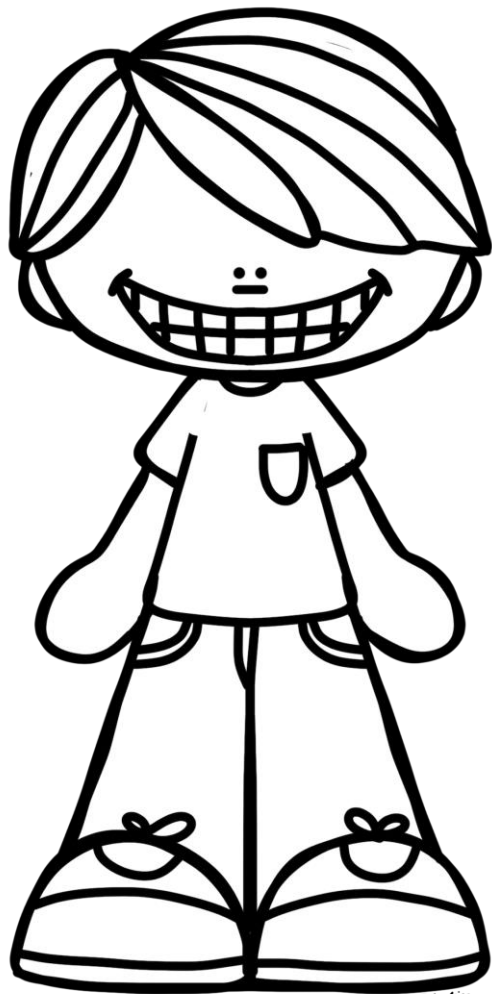

reënboog

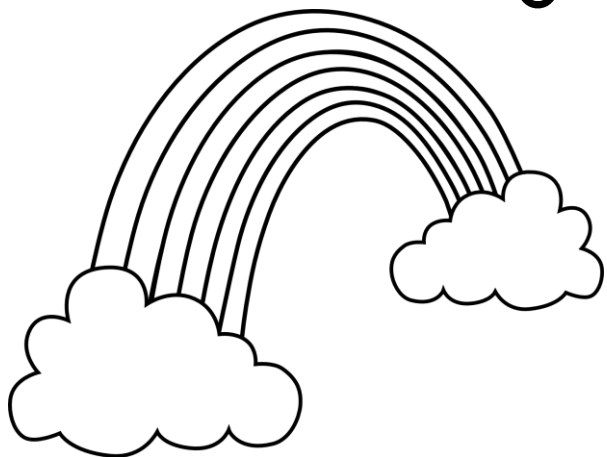

reën



renoster

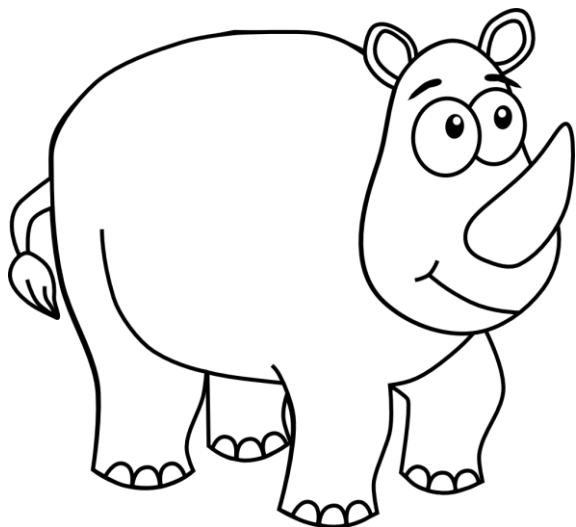

r

ruimtetuig

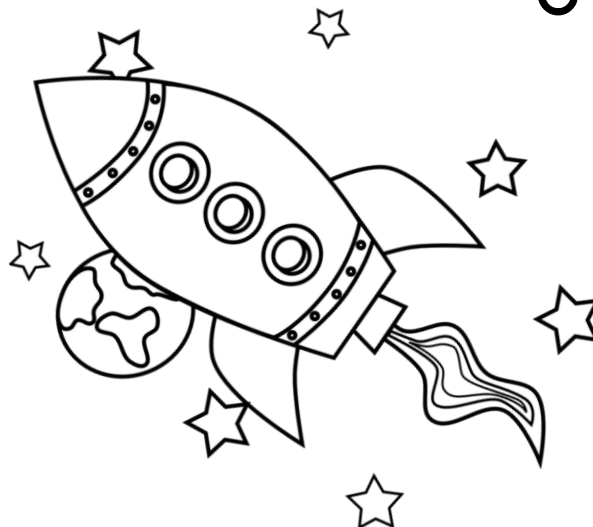

skêr

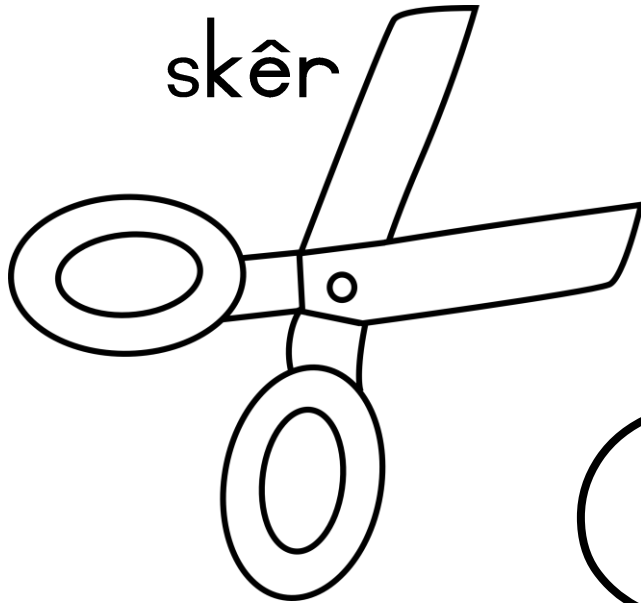

saag

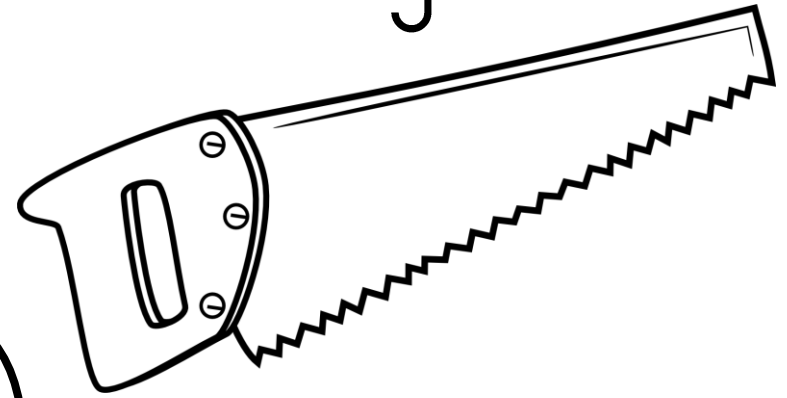

seekat

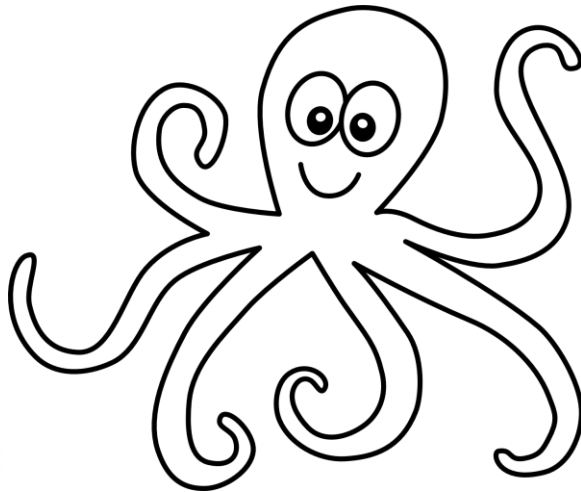

S

son

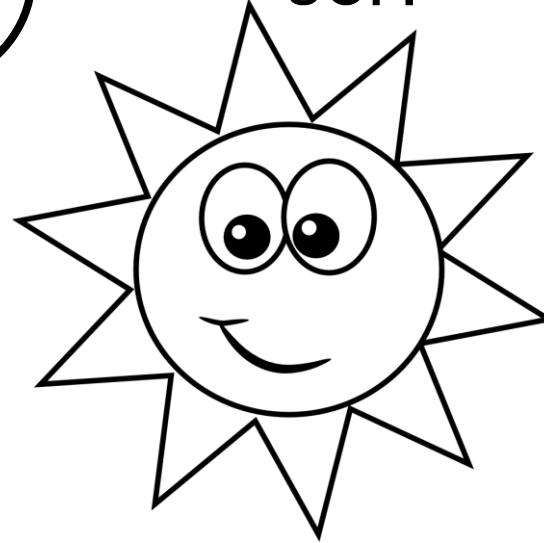

tand

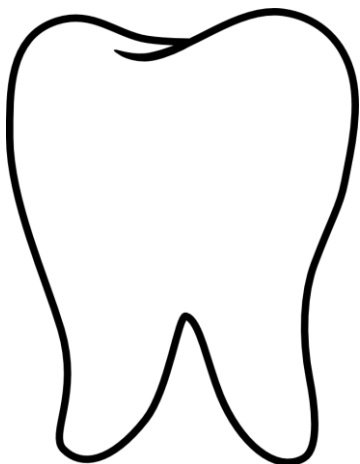

trein

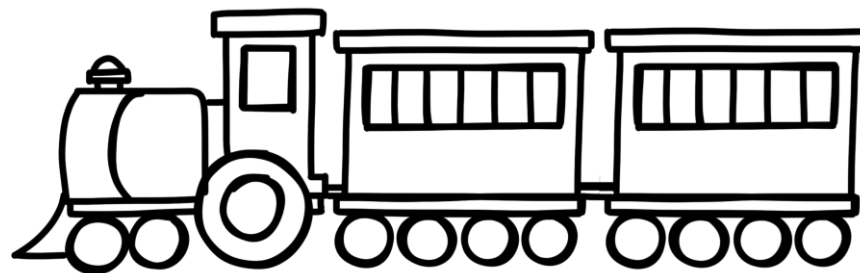

tier

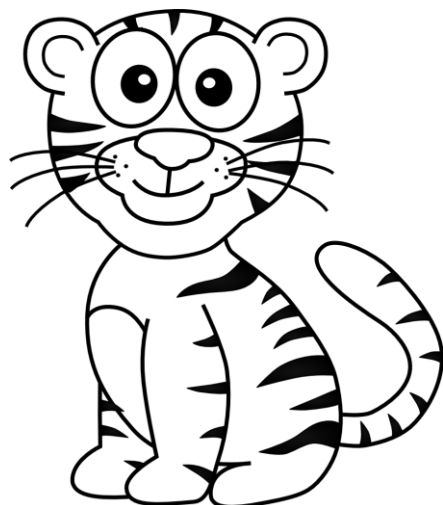

tamatie

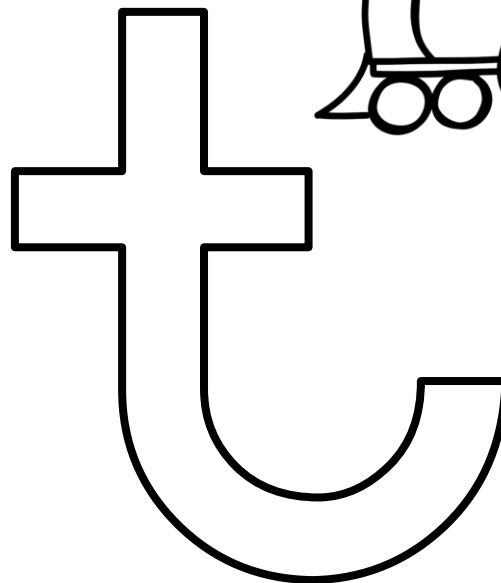
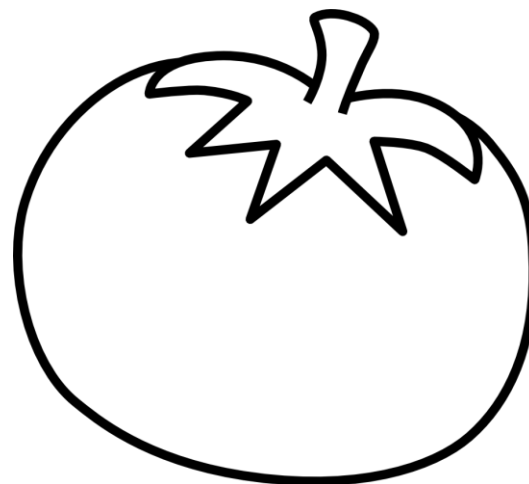

hut



mus



bus

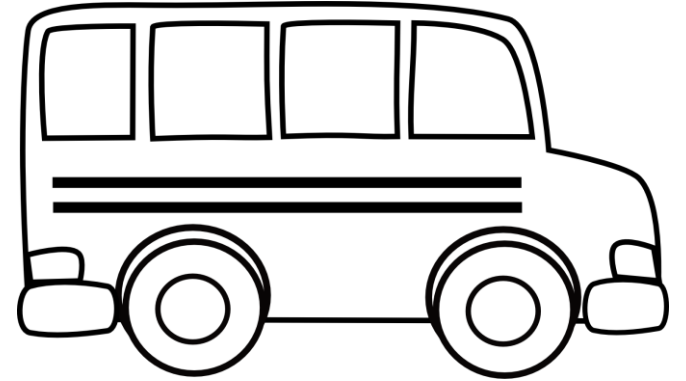

nul

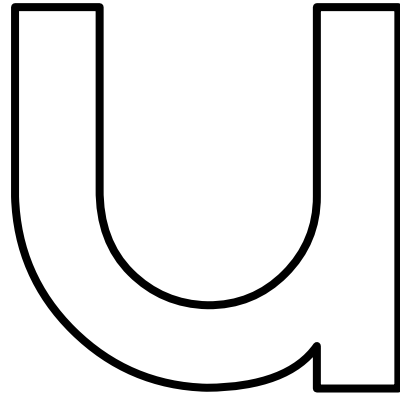
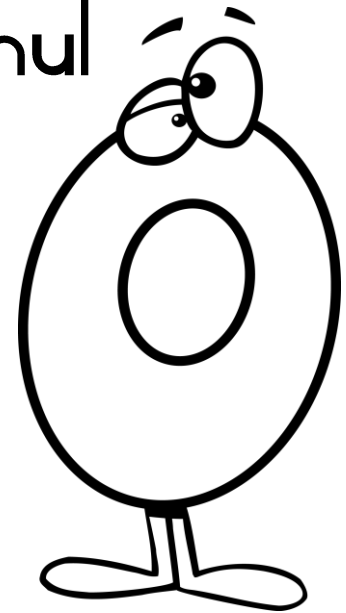

vlieër

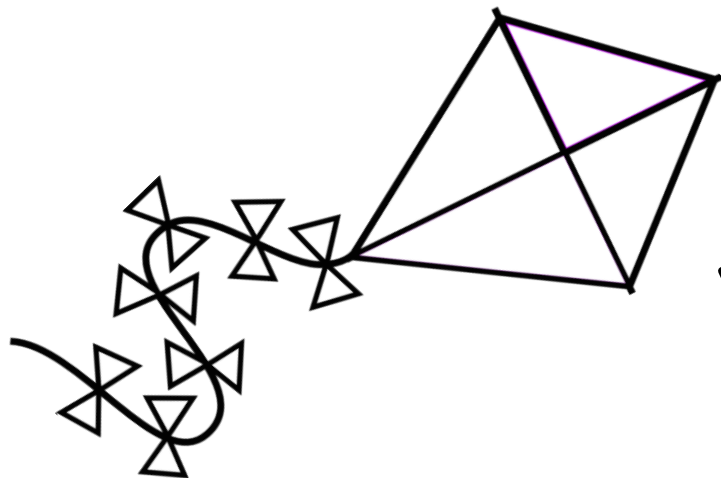

vis

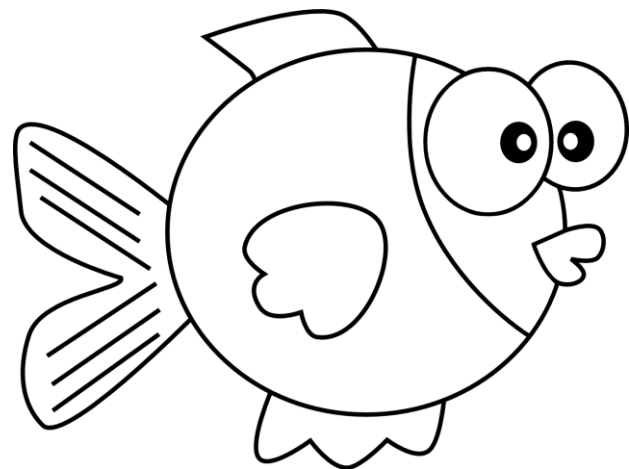

vuur

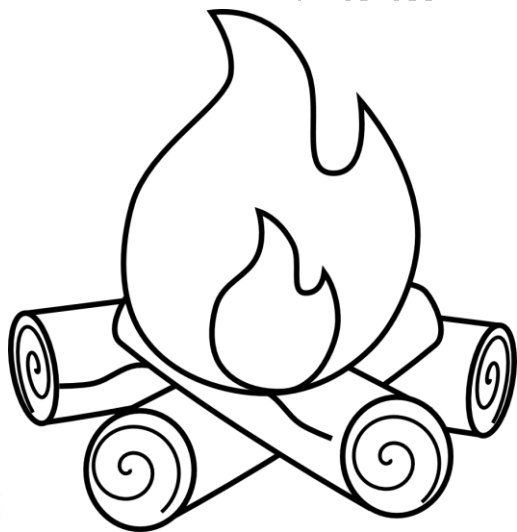

voëltjie

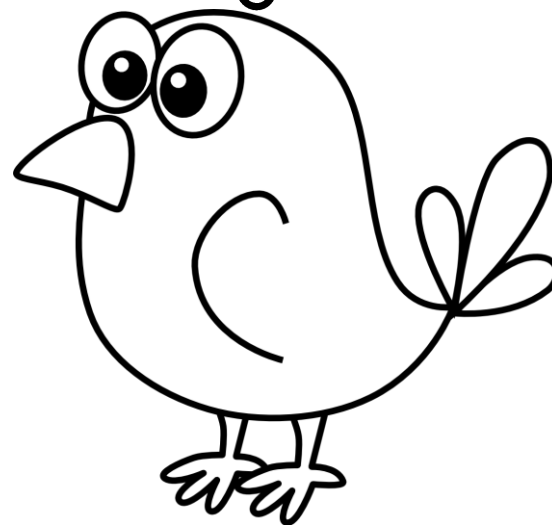

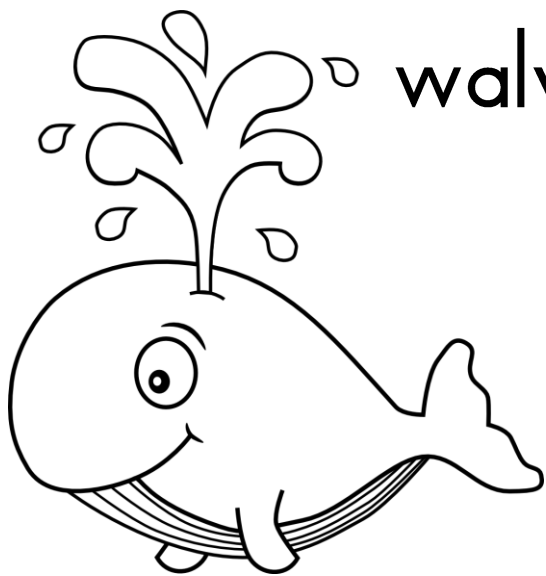

walvis

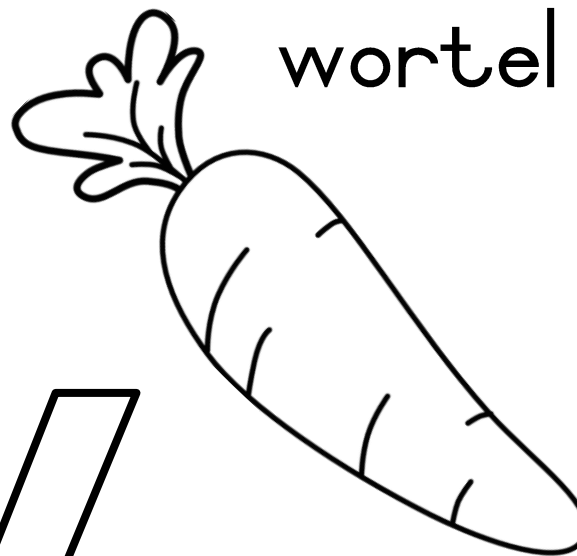

wortel

W

waatlemoen

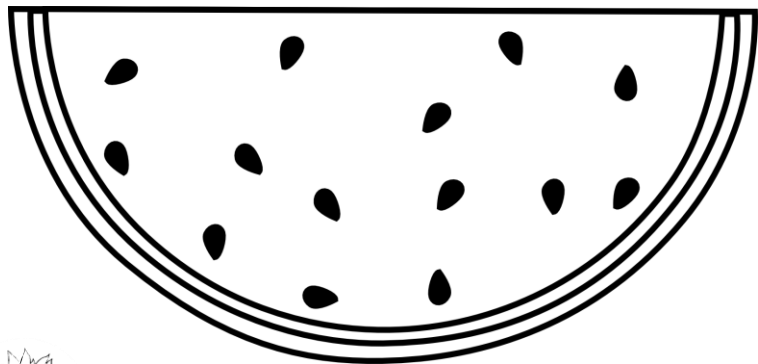

walrus

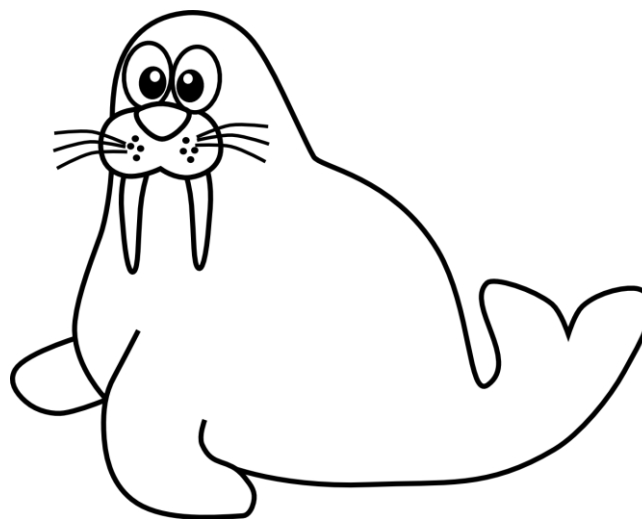

x-straal

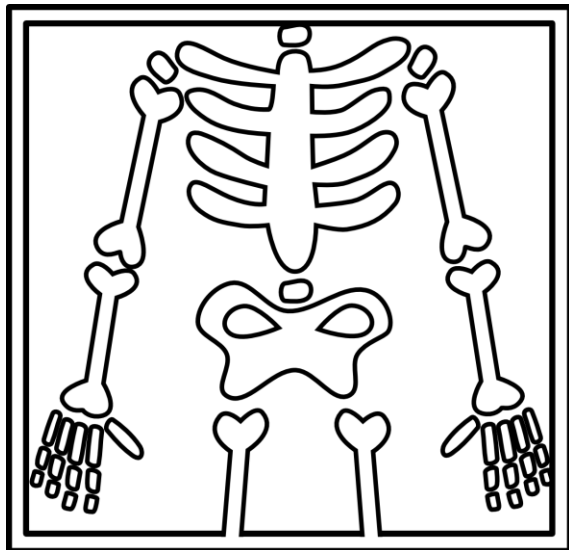

X

xilofoon

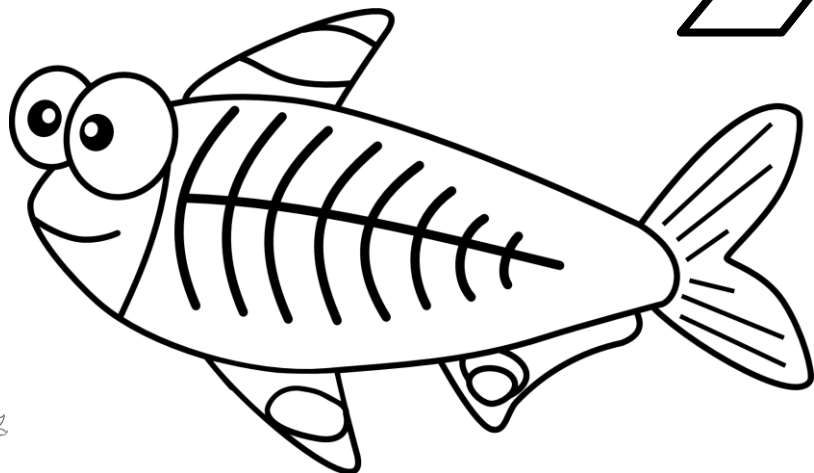
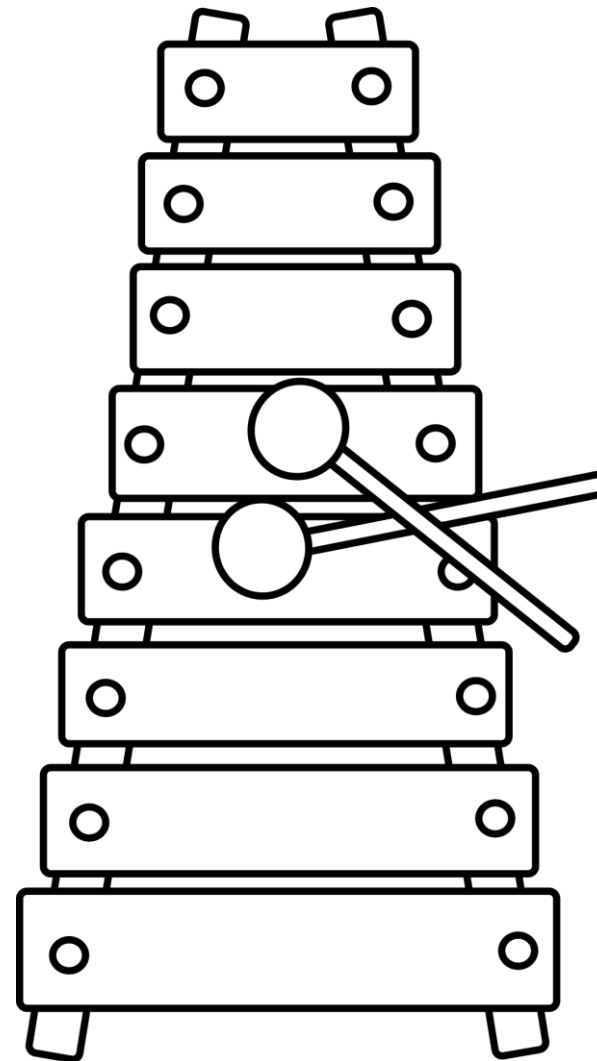

ysbeer



ys

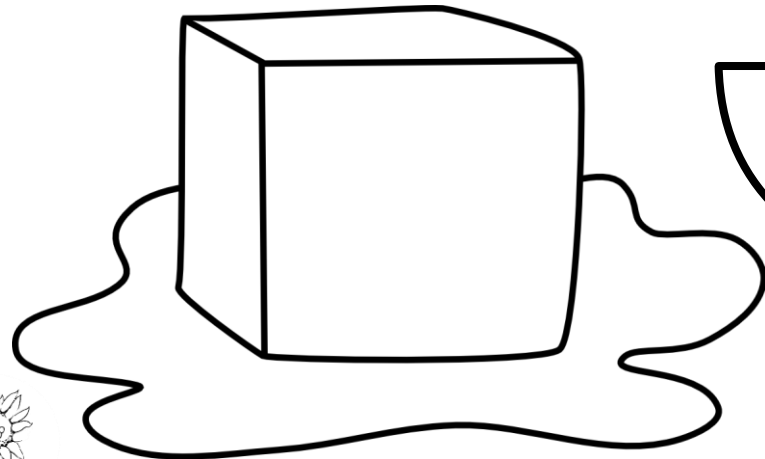

yskoud



yskas

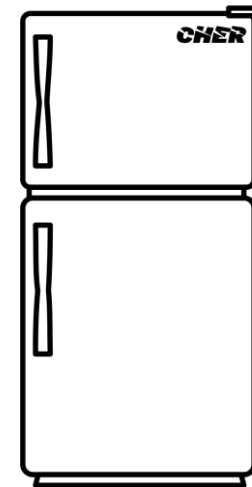

zebra

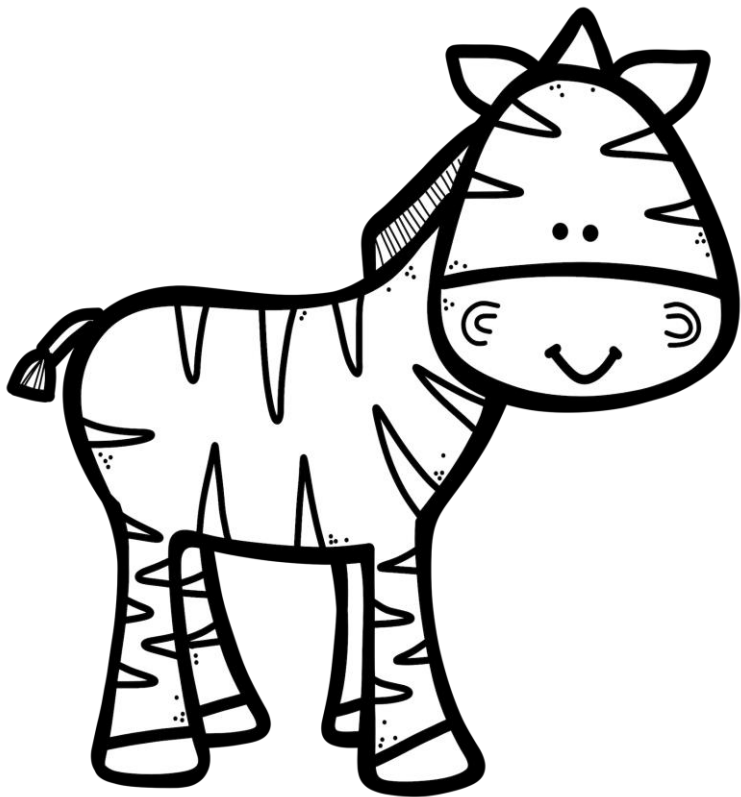

Z

